

Article number: 4395000601

Description: Rota-fix shaft-hub connection F60x90
Stainless steel

Measures

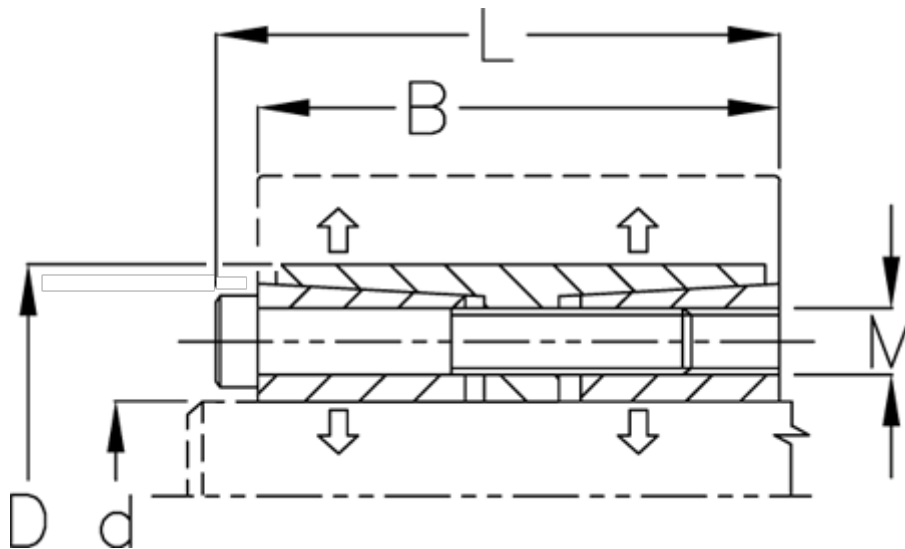

B mm	= 66
d H8 mm	= 60
D mm	= 90
Fit tolerance	= Aksel h8, Nav H8
F kN torque	= 109.0
L mm	= 74
M mm	= M8
P N/mm ² surface pressure on shaft/hub	= 35

Surface roughness	= R? ? 3.2 μm
T N m torque	= 3290
Ts N m bolt tightening torque	= 28.7